

2019 BBJ 787-8





## 2019 BBJ 787-8

### AVIONICS:

Auto Flight: Autopilot & Autothrottle

Communications:

- High Frequency (HF) system
- Very high frequency (VHF) system
- SATCOM system (Aero H+)
- Selective Calling (SELCAL)
- Emergency Locator Transmitter (ELT)

Data Communications Management System:

- Future Air Navigation System-1 (FANS-1)
- Controller-pilot Data Link Communications (CPDLC)
- Automatic Dependent Surveillance (ADS)
- ATS Facilities Notification (AFN)
- Flight Management System (FMS)

Navigation:

- Air data reference function
- Pitot-static probes, static ports, air data modules, and AOA vanes
- Flight management function
- Earth reference system
- Dual integrated navigation radio (INR) system
- Dual radio altimeter system
- Dual distance measuring equipment (DME)
- Dual integrated surveillance system (ISS)
- Dual Integrated Navigation Radio (INR)
- Global positioning system (GPS)

- Global navigation satellite system (GNSS) landing system (GLS)
- Instrument landing system (ILS)
- VHF omni-directional range (VOR)
- Marker beacon (MB) system

Indicating/Recording Systems and Flight Display:

- Cockpit Voice Recorder (CVR)
- Flight Deck Entry Video Surveillance (FDEVSS)
- Flight Data Recorder System (FDR)
- Multi-Function Displays (MFD)
- Primary Flight Display (PFD)
- Dual head-up displays (HUD)
- Weather Radar (WXR) System
- Independent Position Determining
- Traffic Alert and Collision Avoidance System (TCAS)
- Air Traffic Control (ATC) Transponder System
- Terrain Awareness and Warning System (TAWS)
- Distance Measuring Equipment (DME)
- Automatic Direction Finder (ADF)
- Flight Management Computing System (FMCS)



## 2019 BBJ 787-8

### INTERIOR:

39 Passenger + 8 Cabin Crew Configuration, including:

- Master Suite, Open Lounge, Guest Seating, Gym
- 2,415 square feet (224 square meters) Living Space Cabin Entertainment
- In-flight entertainment: IDair IFE & CMS (Cabin Management system)
- Moving Map: Betria 3D Map System
- Internet : Panasonic eXconnect Global Communications Suite (KU Band)
- Power Outlet : 120V/60Hz

### VIP LOUNGE:

The VIP lounge offers a private gathering space ideal for business, dining or relaxation.

- 4 Passenger Seating
- 65" Monitor
- Surround Sound
- Electric Dining/Conference Table
- Dedicated Tablets for Cabin Control
- Hand-Tufted Carpet with Silk Accents
- 4 Full Height Closets for Storage
- Seat Conversion into Queen Size Bed

### MASTER BEDROOM:

The Master Bedroom provides a sanctuary for rest and relaxation, with a private desk for business or leisure.

- 65" Monitor
- Surround Sound Audio
- Nightstand with Tablet and charging station

- 2 Full Height Closets
- Drawers and Open Shelving Storage
- Private Desk Space
- Accent Lighting
- Enhanced Sound Dampening

### MASTER WASHROOM:

The Master Washroom offers a spacious shower, beautiful stone veneer and premium vanity lighting ensuring you'll arrive at your destination refreshed and rejuvenated.

- Large, Single Sink Vanity
- Oversized Shower
- Custom, Golden Bronze Plating
- Hand-painted Lacquer wall Panels
- Calcutta Marble Countertop

### MAIN DINING LOUNGE:

The extensive, open lounge features areas for casual meetings, entertaining guests or relaxing. Configured with two divans, elegant conference/dining tables, single seats and flat screens, this multi-functional space provides a great place to socialize and unwind during your flight

- 65" Monitor
- Accommodates 16 Passengers
- Window Accent Lighting
- Electric Dining/Conference Tables with Removable Leaf
- Dedicated Tablets for Cabin Control
- Hand-Tufted Carpet with Silk Accents
- 2 Storage Buffets with Calcutta Marble Tops
- Unique Tile Artwork Leading to an oversized Lavatory



## 2019 BBJ 787-8

### MAIN DINING LOUNGE:

The extensive, open lounge features areas for casual meetings, entertaining guests or relaxing. Configured with two divans, elegant conference/dining tables, single seats and flat screens, this multi-functional space provides a great place to socialize and unwind during your flight.

- 65" Monitor
- Accommodates 16 Passengers
- Window Accent Lighting
- Electric Dining/Conference Tables with Removable Leaf
- Dedicated Tablets for Cabin Control
- Hand-Tufted Carpet with Silk Accents
- 2 Storage Buffets with Calcutta Marble Tops
- Unique Tile Artwork Leading to an oversized Lavatory

### BUSINESS CLASS:

The Business Class Cabin ensures your guests will arrive at their destination rested.

The cabin accommodates 18 passengers with first class seats featuring custom, ergonomically designed leather cushions for optimum comfort, personal monitors and touchscreen IFE controls. Large overhead bins ensure ample storage for all guests.

### GYM:

- 27" Monitor
- Treadmill
- Full-wall Mirrors
- High Ceiling
- Full Height Cabinet for Storage

### GALLEYS:

Galleys interface with standard connections for power, signals, water, waste, oxygen, conditioned air, and vents similar to lavatories.

Two galleys are installed:

- Fwd Galley: A transverse galley at door 1, in a fixed center location, with room for six carts. This galley has electrical power, plumbing for water, and refrigeration.
- Aft Galley: A U-shaped galley at door 4, in a fixed aft position, with room for fifteen carts. This galley has electrical power, plumbing for water, and refrigeration.

Galley Equipment includes:

- Tri-mode Chiller/Fridge/Freezers
- Steam Ovens
- Espresso Makers
- Beverage Makers
- Multiple Chilled Carts

### CREW AREA:

- 2 Forward-Aft bunks with Privacy Curtains
- Reading Lights and Outlets
- Dedicated for the Comfort of Cabin Crew



## 2019 BBJ 787-8

### MORE THAN JUST COMPOSITES:

787 one-piece barrel sections



No longitudinal splices

Traditional panelized sections

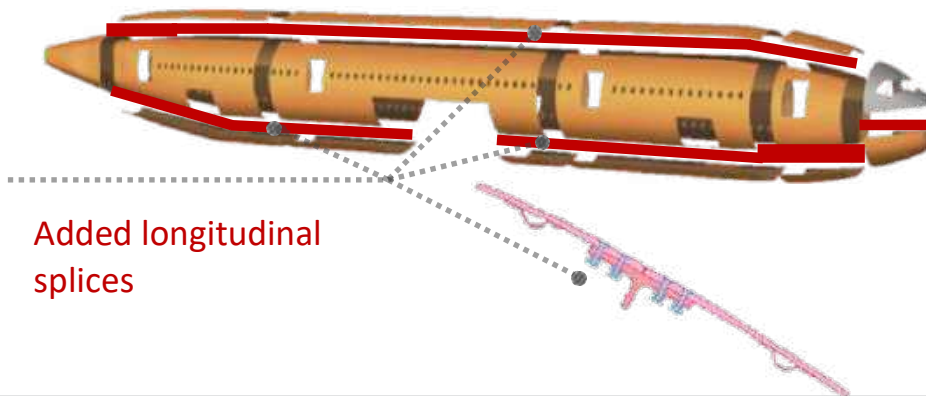

Added longitudinal splices

### BBJ 787 advantage

- Lower weight
- Fewer parts and fasteners
- Less maintenance
  - Fewer joints
  - Fewer inspections
  - No metal-composite thermal expansion mismatches
- Technology exclusive to 787





## 2019 BBJ 787-8

### ADVANCED AERODYNAMICS:

#  
Visionary design





## 2019 BBJ 787-8

### TUBE SIZE:

BBJ 787, A350XWB and A330/340

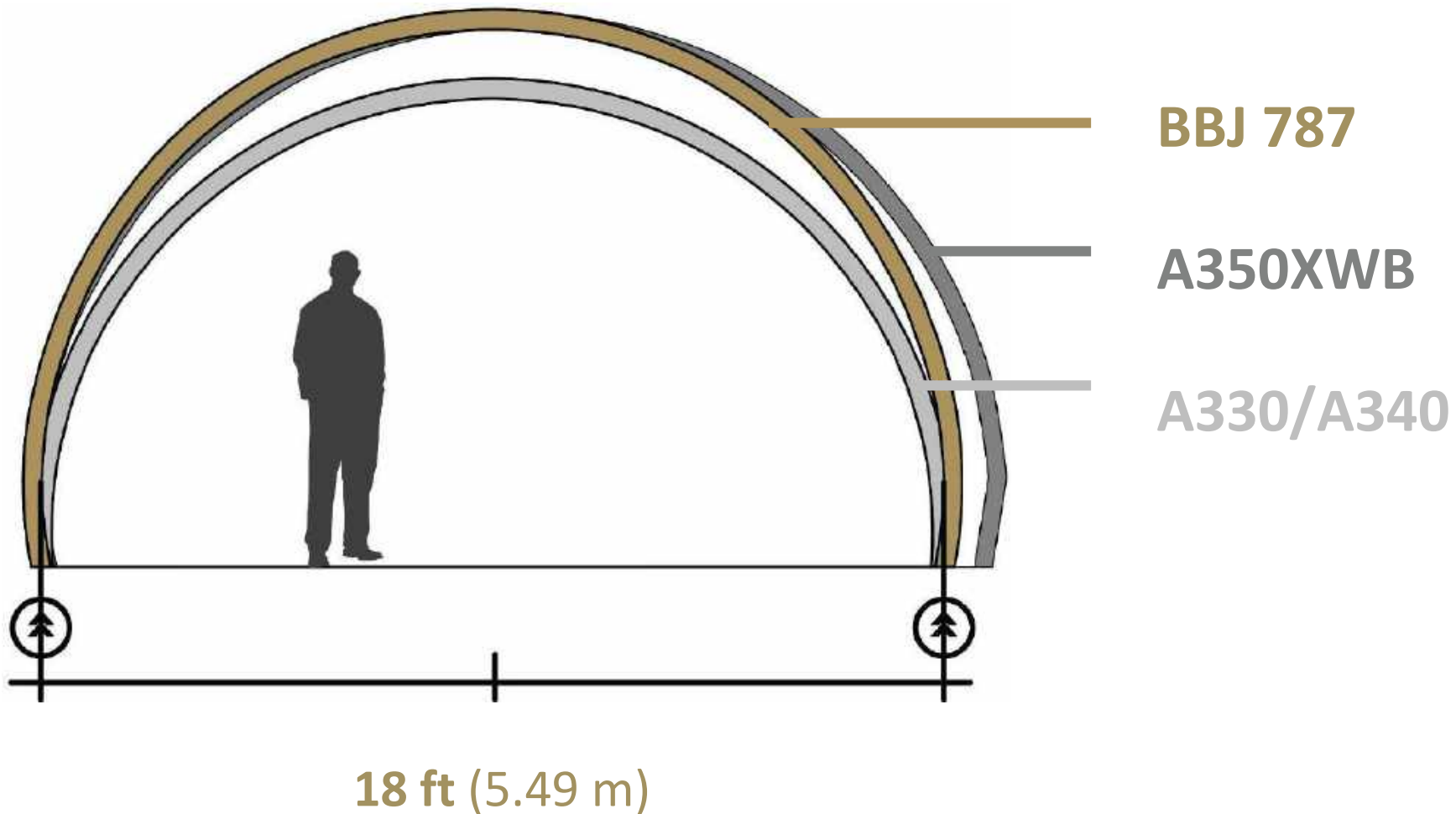





## 2019 BBJ 787-8

### LOWER CABIN ALTITUDE:

Less fatigue and fewer headaches

### Passenger comfort is significantly improved by reducing cabin altitude to 6,000 ft

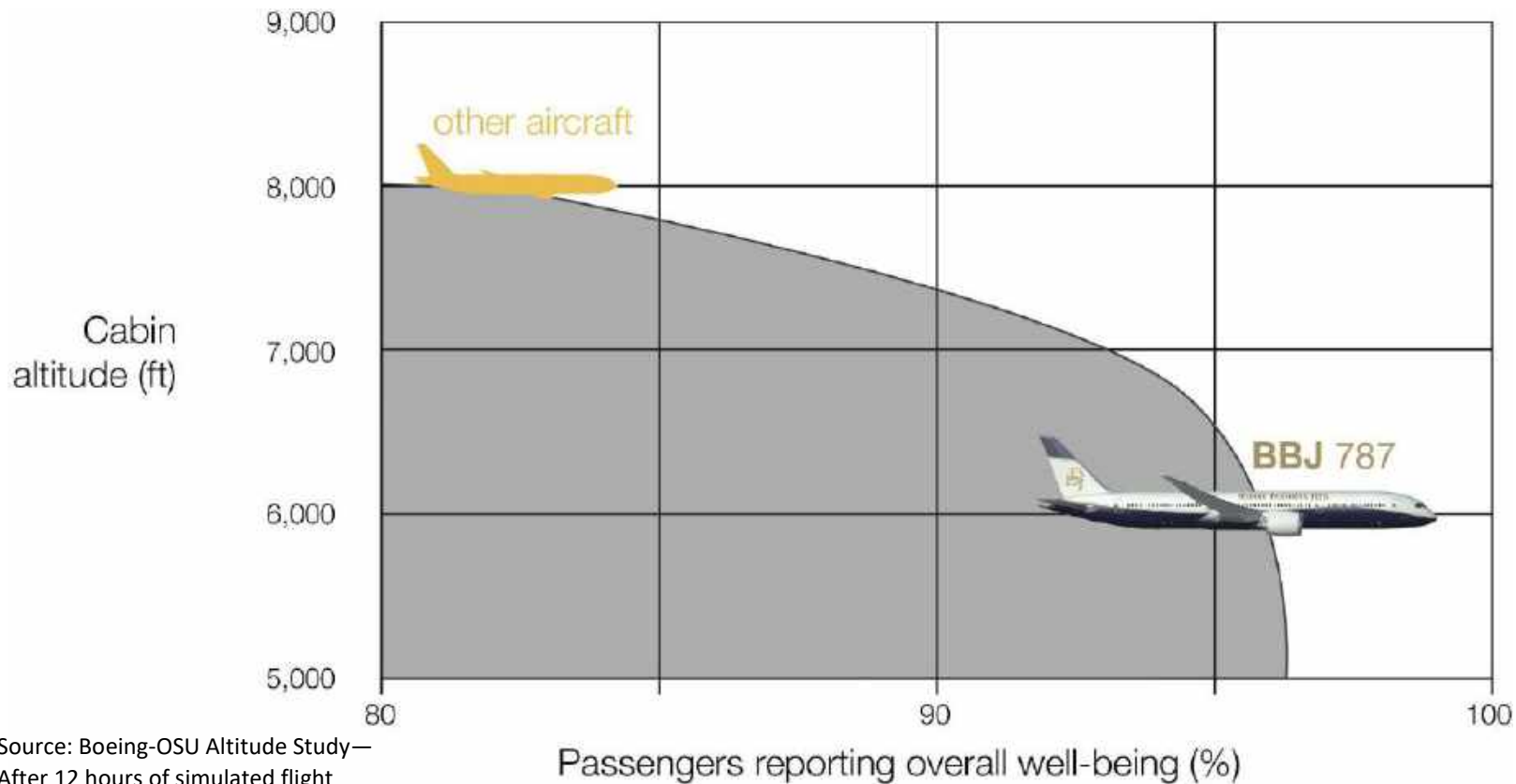

Source: Boeing-OSU Altitude Study—  
After 12 hours of simulated flight



## 2019 BBJ 787-8

### BETTER AIR QUALITY:

Healthier air from advanced air filtration

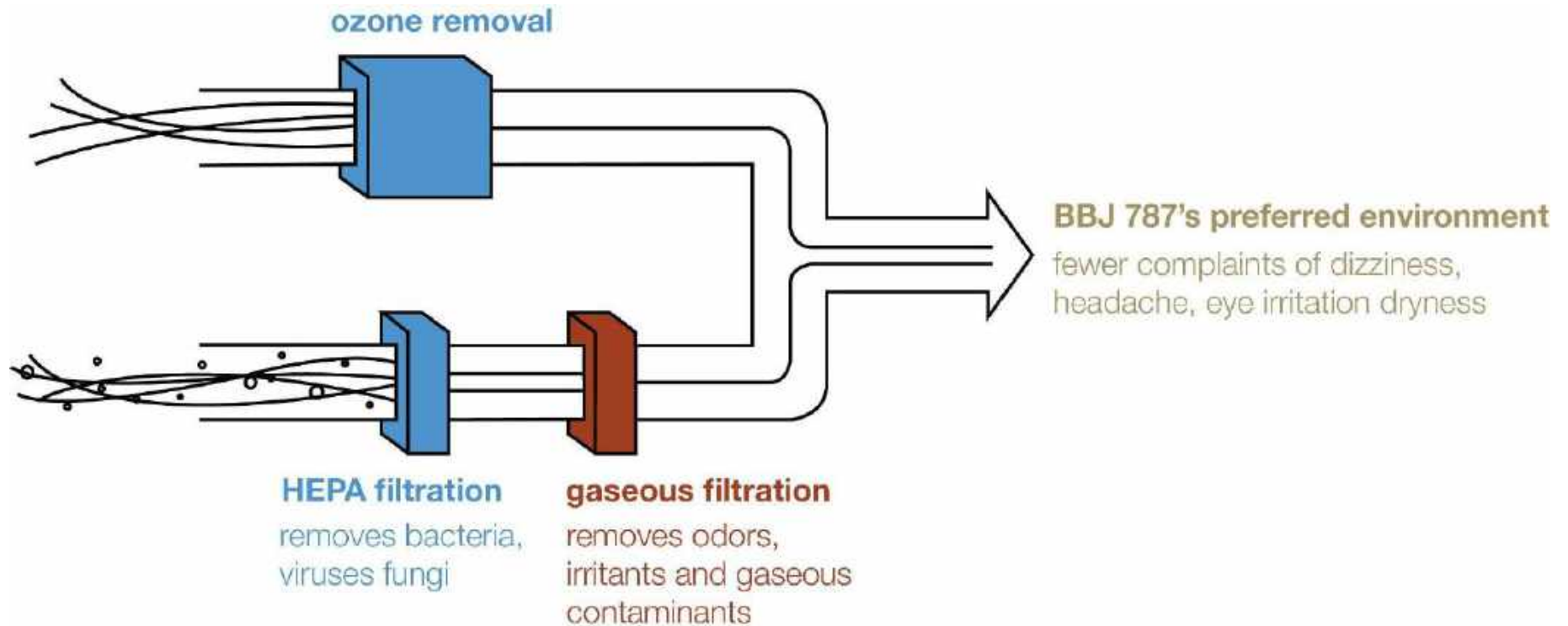



## 2019 BBJ 787-8

### LARGER WINDOWS:

A breathtaking view

787 windows are placed higher on the fuselage for easier viewing

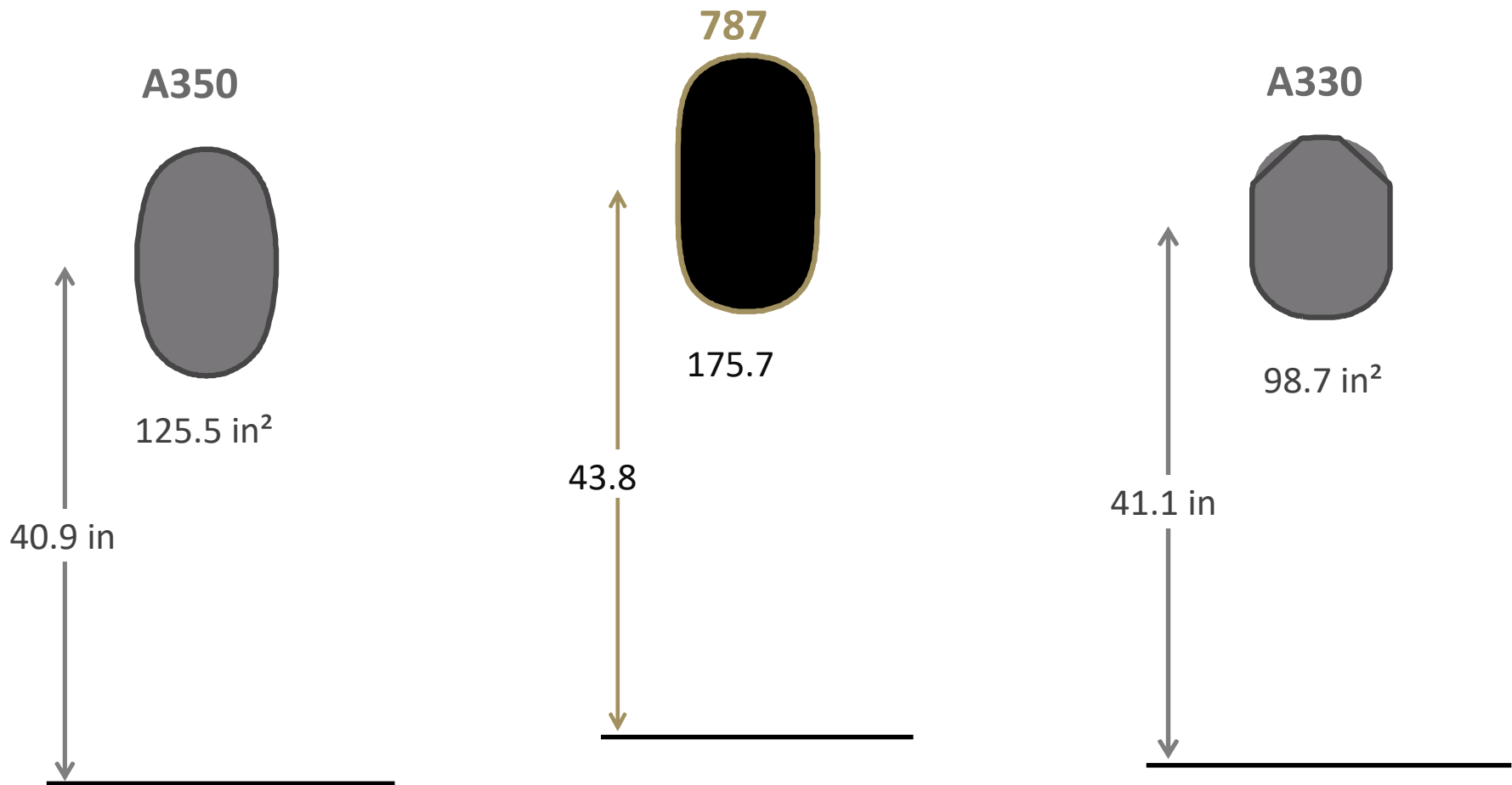



## 2019 BBJ 787-8

### ELECTRONIC WINDOW DIMMING:

Collectively controllable throughout the cabin





2019 BBJ 787-8

SMOOTHER RIDE:

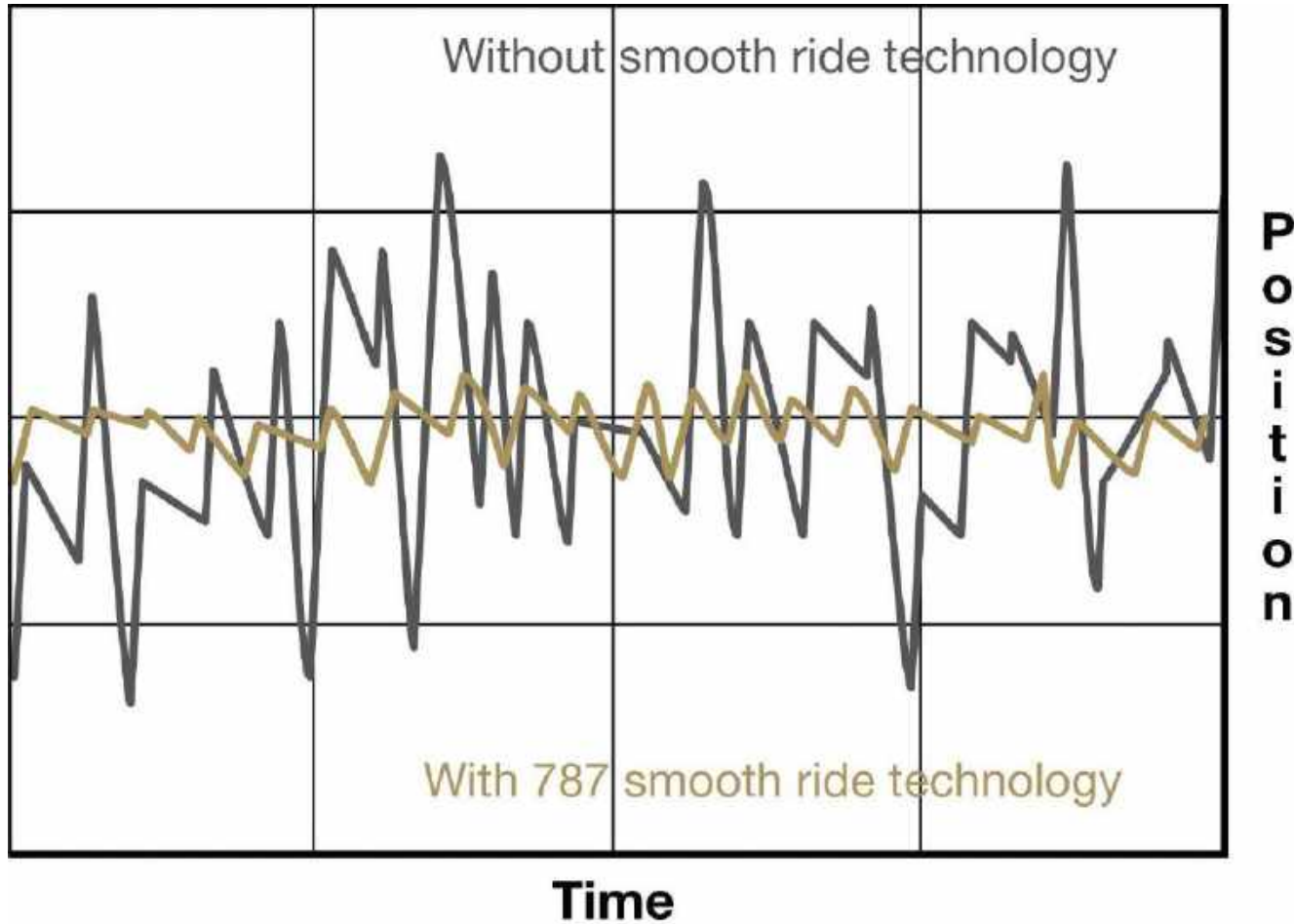

- Reduces the effects of moderate turbulence
- 8-fold reduction in number of passengers experiencing motion sickness



## 2019 BBJ 787-8

### MAINTENANCE:

Longer intervals mean more time spent flying

Intervals	A330neo	767	BBJ 787
A-check	800 hrs	750 hrs or 300 cycles	12 months
C-check, months	24	18	48
D-check, years	6	6	16

New standards



---

## 2019 BBJ 787-8

---

### RANGE CAPABILITY—FROM LONDON:

Estimated range

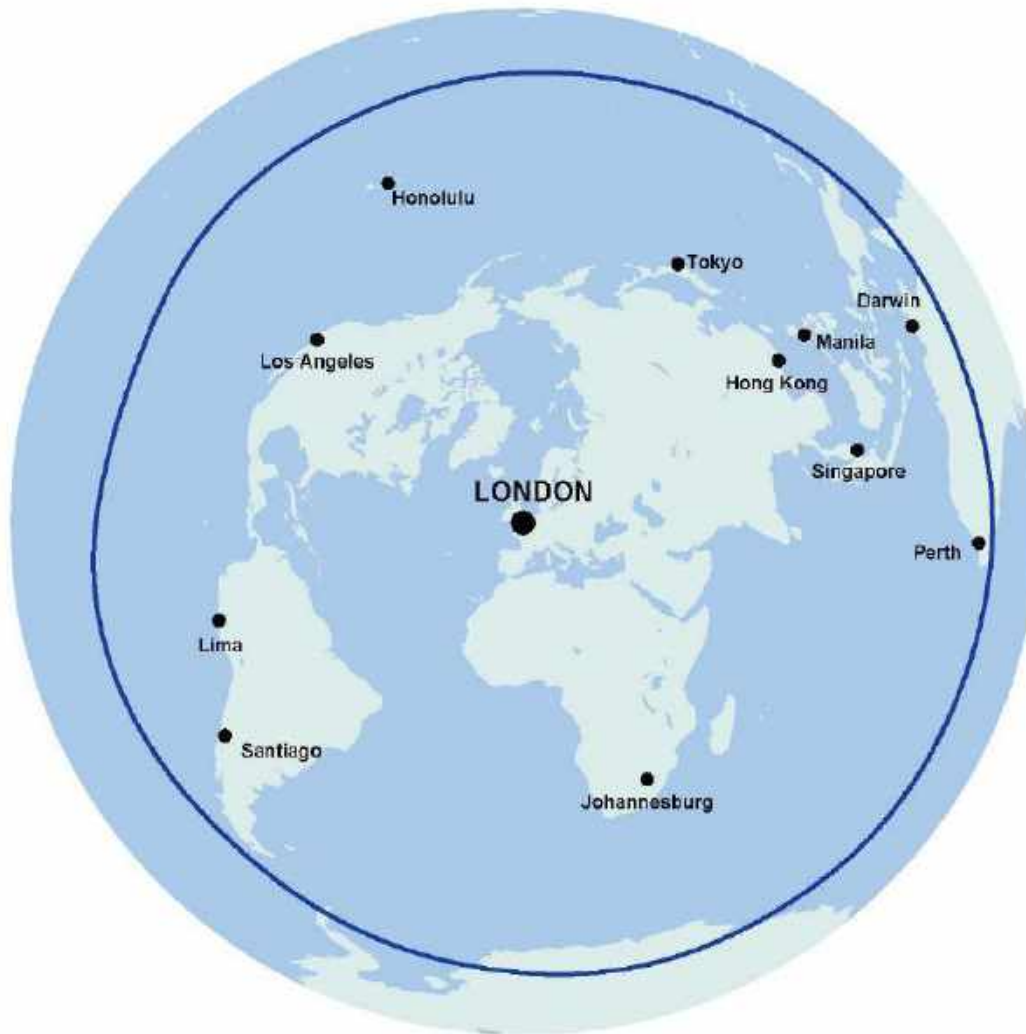



Contact: Alireza Ittihadieh  
[alireza@freestream.com](mailto:alireza@freestream.com)  
[alireza@freestreamhongkong.com](mailto:alireza@freestreamhongkong.com)

2019 BBJ 787-8



[WWW.FREESTREAM.COM](http://WWW.FREESTREAM.COM)

Freestream Aircraft Limited  
London  
+44 207 584 3800  
[sales@freestream.com](mailto:sales@freestream.com)

Freestream Aircraft (Bermuda) Limited  
Hamilton, Bermuda  
+1 441 505 1062  
[sales@freestreambermuda.bm](mailto:sales@freestreambermuda.bm)





Contact: Alireza Ittihadieh  
[alireza@freestream.com](mailto:alireza@freestream.com)  
[alireza@freestreamhongkong.com](mailto:alireza@freestreamhongkong.com)

2019 BBJ 787-8

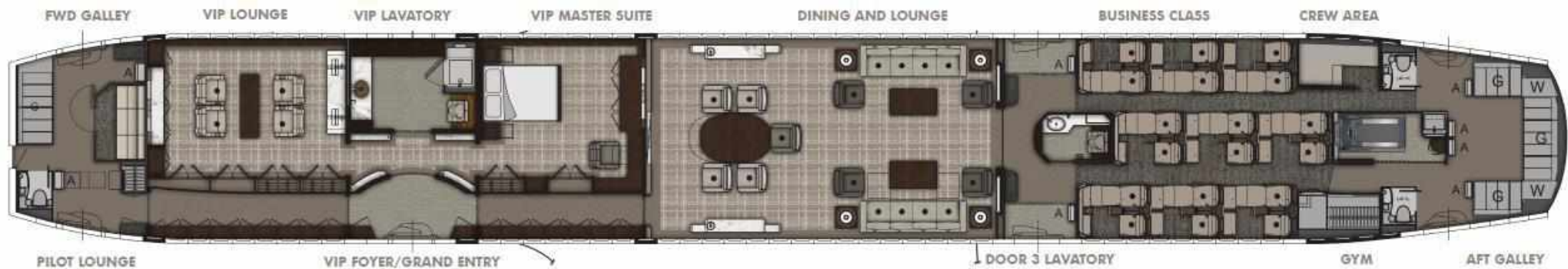

[WWW.FREESTREAM.COM](http://WWW.FREESTREAM.COM)

Freestream Aircraft Limited  
London  
+44 207 584 3800  
[sales@freestream.com](mailto:sales@freestream.com)

Freestream Aircraft (Bermuda) Limited  
Hamilton, Bermuda  
+1 441 505 1062  
[sales@freestreambermuda.bm](mailto:sales@freestreambermuda.bm)



## 2019 BBJ 787-8

Freestream Aircraft Limited is proud to have a team of highly experienced and uniquely qualified aviation consultants. Our team is able to cover all aspects of aircraft brokerage, acquisition, marketing, sales, custom design services, import/export and maintenance review of your aircraft. We specialize in state of the art, medium through ultra-long range corporate jet aircraft and fully understand the importance of attending to all details as required by our clients.

Additionally, our affiliation with brokerage firms worldwide and our collateral buying power with the aircraft manufacturers, assures professional assistance to international and multinational companies as well as private individuals, artists, royalty and head-of-state clients

Freestream's expertise, commitment to integrity, and vast experience provide our clientele the exclusive opportunity to experience a seamless transaction in a timely manner. Principals the world over continue to find their experience with Freestream advantageous and beneficial.

